



LIVE GREEN. SWIM WARM.

QUICK-START INSTALLATION MANUAL

FOR USE WITH:

EAGLE CLAW™ MOUNTING SYSTEM

- SAVE INSTALLATION TIME AND AVOID CALL-BACKS•
- READ THIS MANUAL BEFORE MOUNTING COLLECTORS•

MANUAL CONTENTS

This manual provides a detailed step-by-step procedure for the installation of an Aquatherm Industries Solar Pool Heating System. If the directions are followed correctly and only recommended Aquatherm Industries hardware and components are used, the installed system should provide years of trouble free service, savings, and enjoyment.

CAUTION: SOLAR COLLECTORS ARE OFTEN INSTALLED ON THE ROOFS OF BUILDINGS. UNLESS YOU ARE VERY FAMILIAR WITH WORKING ON ROOFS AND HAVE THE PROPER LADDERS AND SAFETY EQUIPMENT FOR SUCH WORK, YOU SHOULD HIRE SOMEONE WITH THE NECESSARY EXPERIENCE TO DO THE INSTALLATION. FAILURE TO OBSERVE SAFE PRACTICES ON A ROOF OR OTHER ELEVATED STRUCTURE MAY RESULT IN FALLING, LEADING TO SERIOUS INJURY TO YOU.

Product Guide

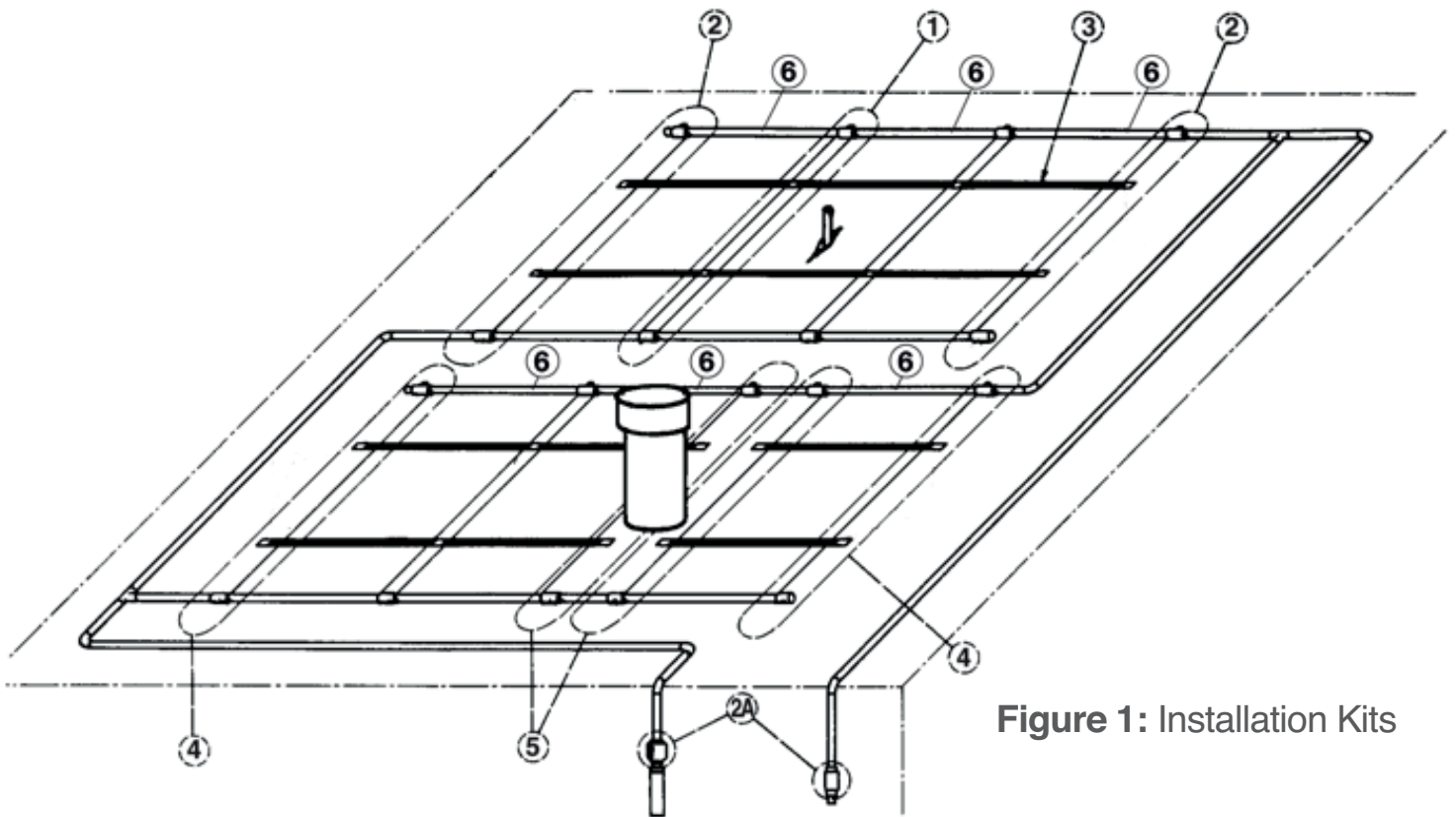

Figure 1: Installation Kits

- 1 Collector Installation Kit**
 (PN 12034-1 for 1½"; PN 12034-2 for 2")
 Contains the parts needed to fasten a single solar collector to a supporting surface and make water connections from one collector to another. *Hold-Down Strap* is not included and must be ordered separately. **One (1) kit required per collector.**
- 2 System Installation Kit**
 (PN 12135-1 for 1½"; PN 12135-2 for 2")
 Includes additional hold-down hardware, connector hoses, and adapters needed to complete water connections from collectors to the system feed and return line. **One (1) kit required per system.**
- 2A Optional Supplemental System Isolation Kit**
 (PN 12033-5) - Permits manual isolation of the solar system from the pool or spa filtration system. Includes a 1½" - 2" PVC union ball valve and a 1½" - 2" PVC check valve. **Use (1) kit per system.**
- 3 Hold-Down Strap**
 (PN 12033-5) - Required to secure collectors to the mounting surface. Use 54' roll (PN 10035-1) for rows of up to six (6) collectors with two straps. Also available in 107' roll for rows up to twelve (12) collectors (PN 10035-2), and bulk 1400' roll (PN 10040).
- 4 Add-a-Row Kit**
 (PN 12043-1 for 1½"; PN 12043-2 for 2")
 Used when more than one row of collectors is to be installed. The kit contains additional hold-down hardware, connector hoses, and adapters. **Use one (1) kit for each row of collectors after the first.**
- 5 Row Spacer Kit**
 (PN 12017-1 for 1½"; PN 12017-2 for 2")
 Contains the hardware needed to space around any width obstruction by connecting appropriate lengths of PVC pipe to the *Pipe Adapters* at the inlet and outlet headers of the two collectors on either side of the obstructions. **Use one (1) for each gap between collectors.**
- 6 Supplemental Outlet Header Clamp Assemblies**
 Used as supplemental outlet header mounting **in conjunction with the Outlet Header Hold-Down Bracket Assembly**. Designed for installations that require more flexibility for the outlet header mounting hardware location, such as barrel tile roofs or installations that require additional mounting hardware to be anchored into rafters or beams. **Use up to two (2) per collector.**



Product Guide

Connections & Hardware



Outlet Header Hold-Down Bracket Assembly
(PN 10008-1, -2)



Flashing Base, Outlet Header
(PN 30340-1)



Hold-Down Strap Bracket
(PN 50006)



Flashing Base, Strap Bracket
(PN 30340-2)



Double Hole Outlet Header Bracket
(PN 50069)



Hold-Down Strap Clamp Assembly
(PN 10011)



Stainless Steel Hose Clamp
(PN 60003-1, -2)



End Cap
(PN 30061-1, -2)



Vacuum-Relief Valve
(PN 10003-1, -2)



Collector Connector Hose (3 3/4" long)
(PN 60690-1, -2)



System Connector Hose (7" long)
(PN 60691-1, -2)



Pipe Adapter (High-temperature CPVC)
(PN 30089-1, -2)



Check Valve
(PN 60019-2)

		Collector Installation Kit (PN 12034-1 / -2)		System Installation Kit (PN 12135-1, -2)		Row Spacer Kit (PN 12017-1, -2)		Add-a-Row Kit (PN 12043-1, -2)	
		1½"	2"	1½"	2"	1½"	2"	1½"	2"
10008-1, -2	Outlet Header Hold-Down Bracket Assembly	1	1	1	1	1	1	1	1
30340-1	Flashing Base, Outlet Header	1	1	1	1	1	1	1	1
50006	Hold-Down Strap Bracket	2	2	2	2	2	2	2	2
30340-2	Flashing Base, Strap Bracket	2	2	-	-	-	-	-	-
10011	Hold-Down Strap Clamp Assembly	-	-	4	4	4	4	4	4
60003-1, -2	Hose Clamp, Stainless Steel	4	4	4	4	4	4	4	4
30061-1, -2	End Cap	-	-	1	1	-	-	1	1
10003-1, -2	Vacuum Relief Valve	-	-	1	1	-	-	1	1
60690-1, -2	Collector Connector Hose (3 3/4" long)	1	1	-	-	2	2	-	-
60691-1, -2	System Connector Hose (7" long)	-	-	2	2	-	-	2	2
30089-1, -2	Pipe Adapter (high-temperature CPVC)	-	-	2	2	4	4	2	2
60019-2	Check Valve (1½" & 2")	-	-	1	1	-	-	-	-
19001	Installation Manual	-	-	1	1	-	-	-	-
19697	Owner's Manual	-	-	1	1	-	-	-	-

Figure 2: System Schematic

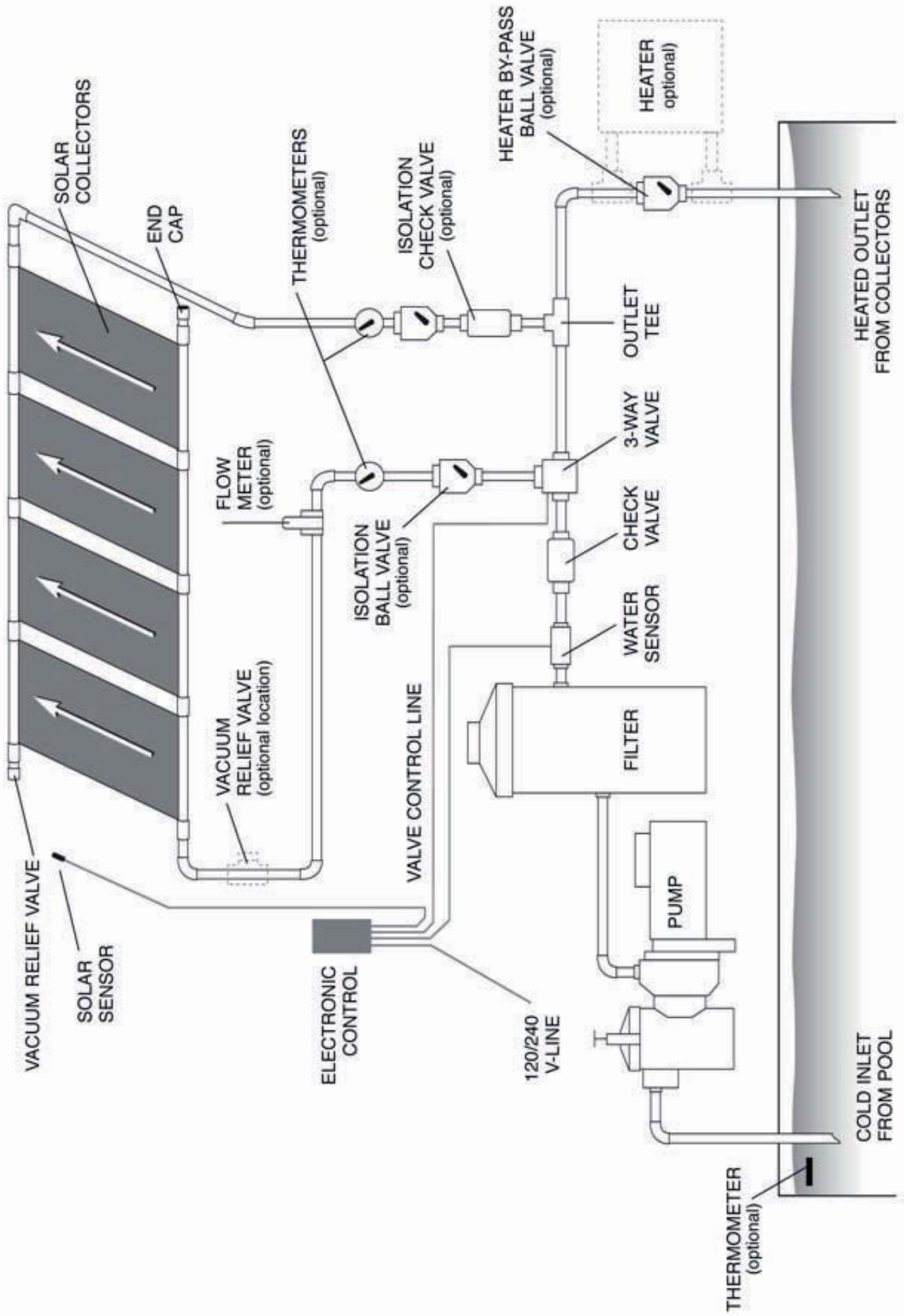

Mounting the Collectors

Collector Layout Overview & Planning for Obstructions



Overview

- When mounting the collectors, always make provisions for inlet connections at the bottom header and outlet connections at the top.
- The outlet headers must be pitched a vertical distance of at least 1/8" per foot (1cm per m) above the inlet headers to assure uniform flow and proper drainage to prevent freezing.
- Plan system location to allow at least 12" (30cm) on all sides of the row(s) of collectors for mounting brackets and piping.

Roof obstructions, if present, should now be taken into account to determine the exact collector location.

Collectors can be installed over or around different diameter roof vent pipes or other obstructions. After snapping the top chalk lines but before marking and pre-drilling for your outlet header brackets, refer to the following instructions:

For roof vents up to 2" (50mm) in diameter the collectors can be installed directly over these vents. Locate the seam in the panel nearest to where the vent pipe is to come through. Separate by pulling up on top plate, and pushing down on the lower plate. Should the vent pipe protrude near a sonic tack weld, it will have to be cut apart. Using a sharp utility knife, cut through the

weld while pulling the two plates apart. Lay the collector over the vent pipe, keeping the vent pipe at least 12 inches (30cm) away from a header. It will be easier to complete an installation by mounting this panel first and then working away from it.

For obstructions up to 7" (18cm) in diameter, the collectors can be positioned on either side of the vent. Two 7" (18cm) long *System Connector Hoses* (PN 60691-1 for 1½" or PN 60691-2 for 2") can be employed to couple the collectors together for vent pipes or other obstacles up to 7" (18cm) in diameter. Mark your 51" (128cm) centers wherever the outlet header brackets 'fall' on the upper chalk line.

For obstructions over 7" (18cm) in diameter, such as attic fans and skylights, position collectors on either side of the obstruction using a *Row Spacer Kit* (PN 12017-1 for 1½"; PN 12017-2 for 2") or *Header Spacers* (PN 30017-1, 2, 3, 4 for 1½"; 30159-1, 2, 3, 4).



Using various configurations of hoses and header spacers, this system avoids roof obstructions while maximizing the solar collector area. (Photo courtesy of Solar Living - Fair Lawn, NJ)

Mounting the Collectors

Step 1: Install Outlet Header Hold-Down Bracket Assembly

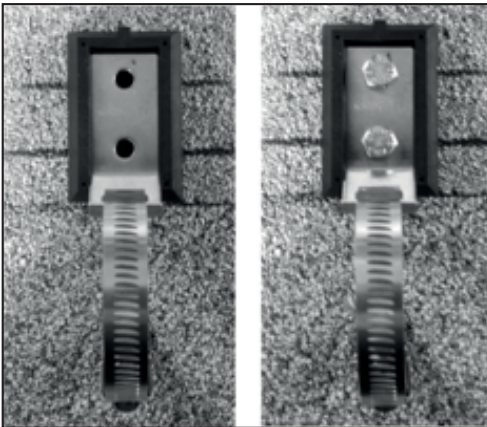

FIGURE 3

1. Determine the position of the last *Outlet Header Hold-Down Bracket Assembly* for the row of collectors, and mark this point on the roof. The collector outlet headers will be located 1" (25mm) below this mark.
2. Using this point, snap a chalk line to the opposite end of the row. **Slope this line down the roof toward the inlet a minimum of 1/8" per foot (1cm per m).**
3. Using a 1/8" (3mm) drill bit (for 1/4" (6mm) diameter screws), drill a pilot hole for the first *Outlet Header Hold-Down Bracket Assembly* on the first roof mark.
4. Measure up 1" (25mm) on center from the first pilot hole and drill a pilot hole for the second screw. Repeat this process all along the chalk line for the total number of collectors to be installed.
5. Inject a generous amount of high quality sealant into each hole and onto the surrounding roof surface. Attach the *Flashing Base & Outlet Header Hold-Down Bracket Assembly* to the roof as shown in **Figure 3**.

Step 2: Hold-Down Strap Bracket Locations

1. Locate the *Hold-Down Strap Bracket* (PN 50006) locations using Table 1 below. Measure "(A) Distance" down from the top *Outlet Header Bracket*, and snap a chalk line to the opposite end of the row. If using the *Optional Supplemental High Wind Area Collector Hold-down Kit*, use (A2) Distance from the outlet header for all three top straps
2. The "(B) Distance" can be measured after the collectors are installed, and is the same for all collector sizes: 16" (40cm) up from the bottom of the inlet header.



Wait to install the Hold-Down Strap Brackets until after collectors are installed, so as not to damage the collectors when you are bringing them to the roof for installation.

TABLE 1 DISTANCE BETWEEN COLLECTOR HEADERS AND STRAPS

Collector Panel Size, Feet (m)	12 (3.6)	10 (3.0)	8 (2.4)	6 (1.8)	4 (1.2)
(A) Distance from Outlet Header, Inches (cm)	60 (152)	48 (122)	36 (91)	24 (60)	-
(A2) Distance from Outlet Header, Inches (cm)	32 (81)	28 (71)	20 (51)	-	-
(B) Distance from Inlet Header, Inches (cm)	16 (40)	16 (40)	16 (40)	16 (40)	16 (40)

Mounting the Collectors

Step 3: Install Connection Hoses on Collectors



Make sure that the header with the serial number label is used for the outlet or top header. The serial number label must face downwards towards the mounting surface.

1. Bring the first collector to the roof and slip the proper hoses over both ends of the inlet and outlet headers on the last return collector.
2. Use *System Connector Hoses* (PN 60691-1 for 1½”; PN 60691-2 for 2”), at the system’s feed and return points (outlet of the last collector and the inlet of the first collector).
3. Place a hose clamp between the two indicator ridges on the hose, in order to center it over the sealing groove in the header. This clamp must face up so as to be accessible for tightening and not rub against the mounting surface.
4. Make sure you securely tighten each clamp with a nut driver. If a nut driver is not available, a ‘hex’ wrench or screwdriver will suffice.

**The hose clamps must be located between the two indicator ridges on the hose.
Do not tighten more than 35-40 inch-pounds!**

Step 4: Secure Outlet Header Bracket to Collector Connector Hoses

1. Position the collector on the roof so that the center of the outlet *Connector Hoses* are directly beneath the secured Outlet Header Hold-Down Brackets.
2. Open the clamp that is part of the outlet header bracket, insert connection hose and **lightly tighten** the clamp around the hose.
3. Loosely place another clamp over the open end of the hose before installing the next collector in the array. Refer to **Figure 4**.
4. Continue to install all the collectors in the array, coupling them side to side.

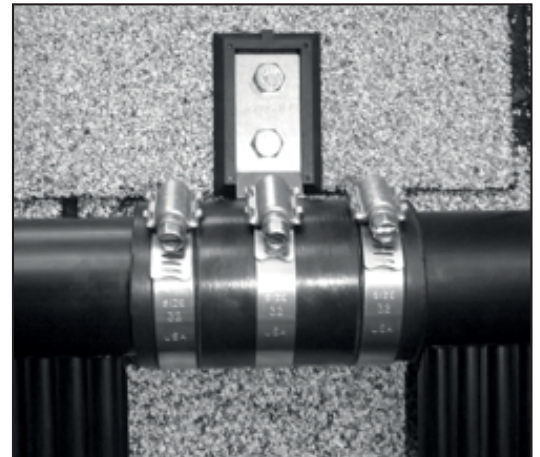

FIGURE 4



Supplemental Mounting Hardware

If using the supplemental *Aluminum Header Clamp Assembly*, (PN 10117-1 for 1½”; PN 10117-2 for 2”), or *GFPP Outlet Header Clamp Assembly*, (PN 10121) install after both the *Outlet Header Hold-Down Brackets* and collectors have been installed.

Mounting the Collectors

Step 5: Install Hold-Down Strap Brackets & Stainless Steel Strap

1. At the lower chalk line previously snapped on the roof, mark locations for the first row of *Hold-Down Strap Brackets* 2" (5cm) away from the first and last collectors and centered between each collector.
2. Drill a pilot hole and apply sealant, then mount the *Flashing Base and Hold-Down Strap Bracket*. Slip a *Strap Hold-Down Clamp* (PN 10011) over the end of the strap prior to pulling it through (refer to **Figure 5**).
3. Loop approx. 2" of strap through the *Outlet Header Bracket* and then back through the *Hold-Down Strap Clamp*. Slide the *Hold-Down Strap Clamp* towards the *Hold-Down Strap Bracket*. The screw should be tightened securely, but not over-tightened to the point where the clamp is distorted (refer to **Figure 5**).

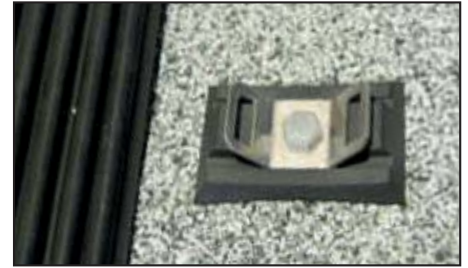

FIGURE 5



For longer arrays it will be easier to start the strap in the middle collectors and work your way out.

4. Moving across the row, drill pilot holes at each marked point between collectors, apply sealant, and attached all *Flashing Bases and Hold-Down Strap Brackets* to the roof.
5. Bring the remaining strap end across the collector face, passing through both slots of the *Hold-down Strap Brackets* between collectors. Pull strap taut against the face of the collectors. Repeat strap termination at opposite end (refer to **Figure 6**).
6. Mark, drill, and mount the remaining *Hold-Down Strap(s)* by repeating the above steps at the distance(s) specified in **Table 1** in [Step 2: Hold-Down Strap Bracket Locations](#).

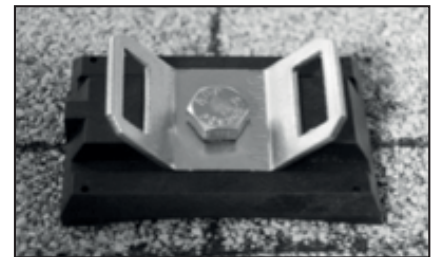

FIGURE 6



It is ok to step on the collectors, as long as you stay one foot away from the top and bottom headers.

Mounting the Collectors

Step 6: Install Vacuum Relief Valve & End Cap



1. Install the *Vacuum Relief Valve* (PN 10003-1 for 1½”; PN 10003-2 for 2”) in the outlet header of each row.

This will be located at the opposite end of the header that is connected to the collector return line.



2. Install an *End Cap* (PN 30061-1 for 1½”; PN 30061-2 for 2”) in the inlet header of each row, opposite the end that is connected to the collector inlet pipe.



Do not over-tighten hose clamp around VRV or End Cap

Installation in High Wind Areas

In regions where high winds are prevalent, use the *Supplemental High Wind Area Collector Installation Kit*, (PN 12035-1 for 1½”; PN 12035-2 for 2”) and *Supplemental Row/System Kit* (PN 12143-1 for 1½”; PN 12143-2 for 2”) in addition to the standard installation kits (**refer to Figure 7**). The included bracket assembly’s spring-tension design allows for collector expansion and contraction, while providing an additional mounting point. *Supplemental High Wind Kits* also contain the required hardware for two additional *Hold-down Straps*. Use **Table 2** below to determine proper spring-tension length, based on collector size and average air temperature.

FIGURE 7

TABLE 2 SPRING TENSION LENGTH

TEMP	8’	10’	12’
0	5”	5”	5”
15			
30	4- 3/4”	4- 3/4”	4- 3/4”
45			
60			
77	4- 1/2”	4- 1/2”	4- 1/2”
85			
100			
115	4- 3/8”	4- 3/8”	4- 3/8”
130			
145	4- 3/8”	4- 3/8”	4- 3/8”
160			

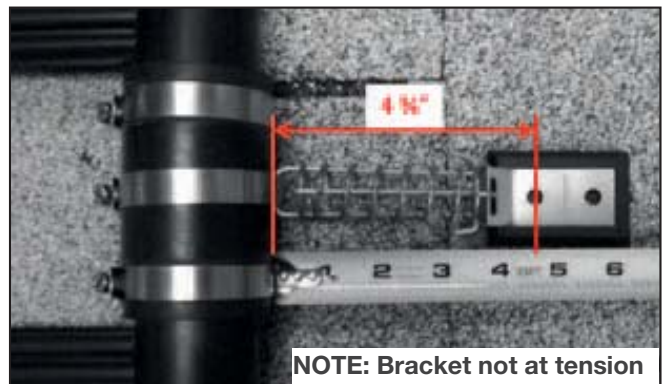

System Piping

Overview

Piping to and from the collectors should be the same type of plastic piping and fittings approved for use with swimming pool filters and pumps. It is recommended to always use Schedule 40 PVC pipe and fittings.

Whenever there is more than 50 gpm (189 Lpm) required flow rate to the collectors or more than 100' (30m) of piping used in a system, install 2" (63mm) piping to and from the collectors. See **Table 3** for Pipe Size Based on Flow Rate.

TABLE 3: PIPE SIZE BY SYSTEM FLOW RATE

FLOW RATE (GPM)	MINIMUM PIPE SIZE @ 7 FT/S VELOCITY (INCHES)	MINIMUM FLOW TO PURGE AIR			SUPPORT CENTERS FOR HORIZONTAL PVC PIPE (FEET) @100°F	
		FLOW-UP	HORIZONTAL FLOW	DOWN FLOW	SDR&SCH. 40	SCH. 80
		2 FT/S	4 FT/S	6 FT/S		
50	1.5	11	22	33	5.0	5.5
80	2.0	20	39	59	5.0	6.0
115	2.5	31	61	92	5.5	6.5
160	3.0	44	88	132	6.0	7.0
300	4.0	78	157	235	6.5	7.5
650	6.0	176	353	529	7.5	9.0
1050	8.0	300	650	1000	8.0	8.5

- If a fuel-fired heater or heat pump is installed, it should be located between the solar return line and the return line to the pool.
- Although PVC pipe is generally white, black is also available but may be difficult to find locally. If black pipe is desired for aesthetics, it can always be painted black. Before painting, the PVC pipe must be wiped with cleaner to remove the glossy surface coating. This will ensure that the paint will not flake off prematurely.
- Use a PVC cutter or a PVC wide-blade saw (not a hacksaw) for cutting pipe. It is important to use both a quality cleaner/primer and solvent in gluing a PVC joint. Finally, use a cloth while either gluing or painting to keep the job a clean one.
- Piping should also be supported at intervals based on pipe size (see **Table 3**). Aquatherm Industries *Pipe Brackets* made from high-strength glass-reinforced polypropylene are available in 1½" (PN 30272-1 black; PN 30284-1 white) and 2" (PN 30272-2 black; PN 30284-2 white).



System Piping

System Piping Configurations

The most common piping configurations use a pressure filter. The pump draws the water from the skimmer and/or a main drain, forcing it through the filter and sending it back to the pool through the return lines. (For other types please contact Aquatherm's Engineering Department).

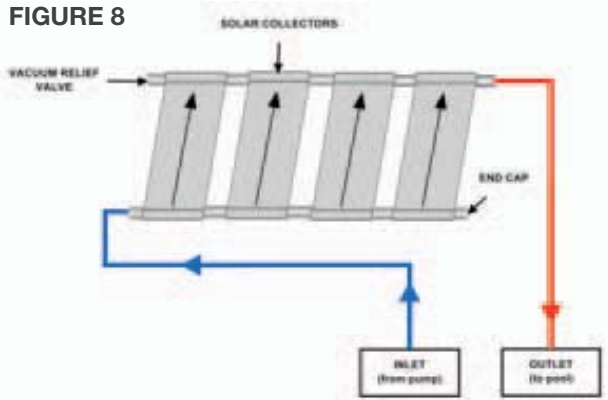

Reverse Return

In a traditional reverse return piping configuration, the feed and return points of each row of collectors will be diagonally opposite each other.

The *Vacuum Relief Valve* and *End Cap* of each row will also be diagonally opposite each other (see diagram at right).

Using a reverse return configuration ensures balanced flow across the entire row of collectors.

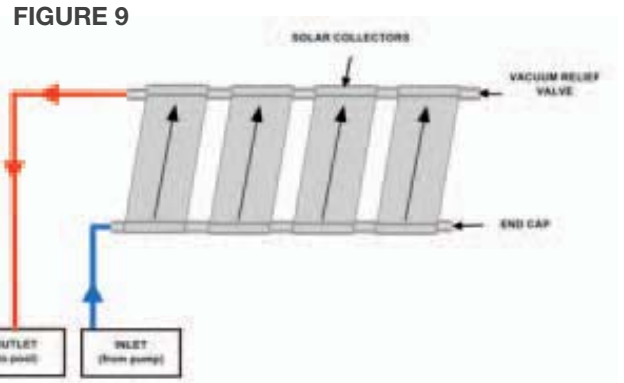

Direct Return

In certain situations, it may be desirable to configure a system with the feed and return points on the same side of a row of collectors (see diagram to left).

Though this configuration reduces the total pipe required, and is often more aesthetically-pleasing, proper flow rates are crucial to ensure balanced flow through each row.

See **Table 4** below to determine the maximum number of collectors allowable in a direct return system at various flow rates.

TABLE 4: REQUIRED FLOW FOR DIRECT RETURN

COLLECTOR SIZE:	8'		10'		12'	
	1½"	2"	1½"	2"	1½"	2"
MINIMUM FLOW RATE (0.06 GPM/FT ²)	-	-	-	-	-	-
STANDARD FLOW RATE, (0.10 GPM/FT ²)	6	6	6	6	6	6
RECOMMENDED FLOW RATE, (0.15 GPM/FT ²)	7	8	7	8	7	7
MAXIMUM FLOW RATE, (10 GPM PER COLLECTOR)	8	12	8	10	8	8

System Piping

Flow Rate

In order to achieve optimum performance from Aquatherm Industries collectors, the recommended flow rates and number of collectors per row in **Table 5** should be followed.



When the system is running, all the collectors should feel uniformly cool to the touch, and there should be no residual air left in the pool return lines. If collectors feel warm or hot to the touch, or air bubbles in the return line persist, chances are that flow through the collectors is inadequate or the system is not properly balanced (refer to the section concerning the **Vacuum Relief Valve Test** on page 14).

- A flow meter can be installed in the collector feed line to check the flow rate. If the flow rates are within the limits as shown above in **Table 5**, the system may not be properly balanced, especially in systems with multiple banks of collectors.

TABLE 5: FLOW RATES

COLLECTOR SIZE, FEET:	4 X 12	4 X 10	4 X 8
STANDARD FLOW RATE PER COLLECTOR, GPM (LPM)	5.0 (18.9)	4.0 (15.1)	3.25 (12.5)
MINIMUM FLOW RATE PER COLLECTOR, GPM (LPM)	3.0 (11.4)	2.5 (9.5)	2.5 (9.5)
MAXIMUM # COLLECTORS PER ROW, 1½"; 2"	10; 12	12; 12	12; 14
MAXIMUM SQUARE FOOTAGE PER ARRAY, 1½"; 2"	480; 576	480; 576	480; 576

PRESSURE DROP (PSI @ GPM): 1½" - 0.05 @ 2.5; 0.13 @ 5.0; 0.39 @ 10.0
 2" - 0.05 @ 2.5; 0.20 @ 5.0; 0.60 @ 10.0



If the flow rate is below the minimum as shown in the table above, then the pool pump size or pipe size should be increased, or a booster pump installed in some cases.

If the flow rate is excessive (more than 10 gpm / 37.9 Lpm) collector), or if the system pressure is greater than 30 psi, a By-pass Check-Valve (PN 60717) should be installed between the collector feed and return lines above the 3-way valve to prevent problems with the collectors and connection hoses.

If the system has been installed according to this manual, optimum performance conditions will now exist. Systems with rows of collectors of unequal size, but fitted with balancing valves, may now be adjusted.

Open all balancing valves completely and let the system run for several minutes. Any row that is warmer to the touch than others is currently receiving less flow than it should for optimum performance. Throttle the valve(s) of the other (cooler) row(s) step-by-step, each time waiting for a few minutes, and check the temperature. Once all rows feel uniformly cool, the system is balanced and operates at optimum performance. Should unexpected problems be encountered, the flow rate must be checked out more thoroughly.

System Piping

Optional Isolation Valves

Isolation valves may be installed in the collector piping, so that the pool may be operated while the collectors are being serviced, or during freezing weather. Install a manually operated ball valve in the system feed line, and a check valve on the return line.

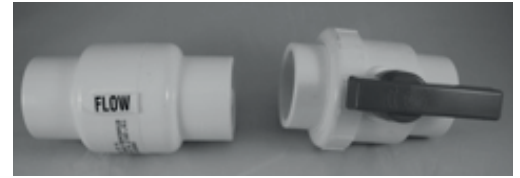

- Both valves, available in the *Supplemental System Isolation Kit* (PN 12033-5) are made to accept either 1½" or 2" PVC pipe. Make sure that the arrow on the check valve is pointing away from the collectors, and that the ball valve and check valve are located close to the control valve and outlet 'T', respectively.

For further precautions in warm climates where pools are operated year round and periodic freezes can occur, a bypass line (small diameter tubing), can be located above the ball and check valve so as to prevent any accidental trapping of water in the collectors by the pool owner. To make sure no water is left in the collectors for servicing or during freezing conditions, remember that the pool pump should be shut off, allowing the collectors to drain naturally, before the optional isolation valves are used.



If the system is installed on a commercial or public pool, local codes may require positive isolation valves in the collector feed and return lines, and a pressure-relief valve in the piping to the collectors.

Control Systems

Control Types

Automatic Control: The performance of a solar pool heater can be maximized with the use of an electronic control and motorized 3-way valve. When solar energy is available, the control activates the motorized valve, sending water through the collectors for heating (or nocturnal cooling). When the pool reaches the set temperature, or there is insufficient solar energy available, the valve will turn to bypass the solar system. Refer to the manufacturer's instructions included with the automatic control you use.

Manual Control: Some systems employ a manual control valve to divert the flow of water to the solar system, though this may reduce the overall heating capacity of the system. Pool water continuously flows through the solar system when the filtration pump is on, but can be diverted manually if the pool becomes too warm or during extended periods of insufficient solar energy. A manual control system consists of a non-positively sealed 3-way valve in place of the motorized valve.

Booster Pump System: In some cases, the existing pool filtration pump may not be able to circulate water at a high enough flow rate to allow for proper collector operation. If so, it may be necessary to replace the filter pump with a larger one, or add a booster pump. An increase in pump size may require an upgraded filter with greater flow ratings.



Regardless of control type, the three-way diverter valve used should be non-positively sealed in order for proper system drain back to occur.

Checking for Operations

System Startup, Testing, and Troubleshooting

Each time the solar system cycles on, there are a few things to watch for:

- ✓ Air will initially be purged into the pool. This may last several minutes.
- ✓ The filter pressure will increase slightly and remain elevated when pool water is flowing through the solar system.
- ✓ When the system is running, all the collectors should feel uniformly cool to the touch.

Vacuum Relief Valve Test: When the solar system is first turned on, air in the collectors will be expelled into the pool and bubbles will appear. The appearance of bubbles in the pool should stop after a few minutes.

- If, after a few minutes, bubbles continue to be discharged from pool returns, remove the *Vacuum Relief Valve(s)* and replace it with an *End Cap*. If the bubbles discontinue, the issue may be the *Vacuum Relief Valve* location.
- If bubbles continue, reverse the *End Cap* and the *Vacuum Relief Valve* on the collector array to see if this stops the bubbles in the return lines.
- If bubbles continue after reversing the *VRV* and *End Cap*, relocate the *VRV* to a position in the inlet piping at a height of approximately 3/4 of the elevation of the collectors above the pool. **Refer to Figure 2.**

Flow Rate Test Methods:

1. **Flowmeter:** The preferred system test method is flow rate. This is also the easiest and quickest method. To check flow rate, install a flow meter in the inlet line to the collectors (follow installation instructions provided with the flowmeter).
2. **Touch Method:** With the system running and the sun shining, all collectors of the system should be uniformly cool to the touch, and the system will be operating at optimum performance.
3. **Temperature Rise Method:** An alternate method to test adequate flow is by measuring the temperature rise of pool water through the system. **It is important that the temperature rise through the collectors be kept as low as possible in order to deliver the maximum amount of heat to the pool.** Use two accurate thermometers - one in the pool water or filtration piping prior to the collectors, and one in the system outlet piping - to measure the temperature rise from solar.
 - Before installing, immerse both thermometers in the pool water for several minutes to compare temperature readings. If they are not identical, make a notation of the difference and add or subtract (as appropriate) this difference to or from the reading taken while you are testing.
 - Turn the pump on and move the flow switch to the “Manual ON” position to divert pool water through the collectors. After at least fifteen minutes of flow to collectors, compare the temperature of the pool water with the water flowing through the outlet piping.



On an average sunny day, with the air temperature approximately 70°F (40°C) the water leaving the collectors should be 1° to 7°F (1° to 4°C) higher than that in the pool. If the water rise is greater than this, insufficient water is flowing through the collectors. This may be caused by a clogged filter, undersized piping, too many elbows in the piping or an inadequate pump.

Maintenance

Pool Service & Maintenance

Backwashing & Adding DE: It is advisable to bypass the solar collectors when either backwashing your filter or adding Diatomaceous Earth (DE). This prevents the possibility of any DE or other debris from passing through the solar system as well as any other pool equipment downstream of the filter. When the backwashing cycle and/or the adding of DE is complete, run the filtration system for 10-15 minutes before returning your solar heating system to operation.

Automatic Pool Cleaning Systems: If you have an automatic pool cleaning system with its own pump, there may be several precautions that you need to take depending on what type of system you have. These precautions prevent the air that is initially purged from the solar system from possibly damaging pool cleaning equipment during the turning on cycle of your solar system.

- **Manual Control:** Do not start the flow of water through the solar collectors while the pool cleaning pump is running. Allow the air to be purged from the system and then activate your pool cleaning system.
- **Automatic Systems:** If your automatic control system is not equipped with a timed pool cleaner delay cycle, it will be necessary to run your pool cleaner in the early morning and turn it off before your solar system comes on; or turn it on in the late morning, well after your solar system normally cycles on. If you manually vacuum your pool, bypassing the solar collectors at this time will provide you with full power for better vacuuming performance.

Cold Weather Operation & Winterization Procedures

During normal operation of the system, when the 3-way valve is in the “bypass collector” position, all water in the collectors should drain back through the 3-way valve (non-positively sealed) when the filter pump shuts off. If there is an isolation ball valve on the feed line, it should only be closed after the collectors have drained fully. Provided collectors are drained, there are no further requirements for winterizing the solar collectors. The pool piping should be winterized as per your normal practice.

In some areas, pool owners operate their pools throughout the winter although light freezing conditions may occur. When solar heaters are used on a pool under these conditions, anti-freeze precautions should be taken. In order to protect the collectors as well as appurtenant components such as *End Caps* and pipe fittings against unusual or severe freezing conditions, one of the following two procedures should be followed when freezing weather is imminent.

1. If isolation valve(s) have been installed, turn circulating system off and allow solar collectors and piping to drain. Close isolation valve(s) if applicable. Switch the solar control to “OFF” or “Solar Disabled”. The pool filtering system may then be turned back on. When freezing conditions have passed, open isolation valve(s) and switch the solar control to “AUTO” or “Solar Enabled”.
2. If the system can not be drained and isolated, the accepted procedure for avoiding freezing of the pool piping and filtration system has been to continuously circulate the water. Switch the solar control to the “Manual ON” position so that water circulates through the collectors. When freezing conditions have passed, switch the solar control to “AUTO” or “Solar Enabled”. **This method is not recommended where temperatures may drop severely.**

Booster Pump System Diagram

In some cases, the pool filtration pump may not be able to circulate water at a high enough flow rate to allow for proper collector operation. If so, it may be necessary to replace the filter pump with a larger one or add a booster pump. If the pump size is increased, it may also be necessary to upgrade the filter to one with greater flow ratings.

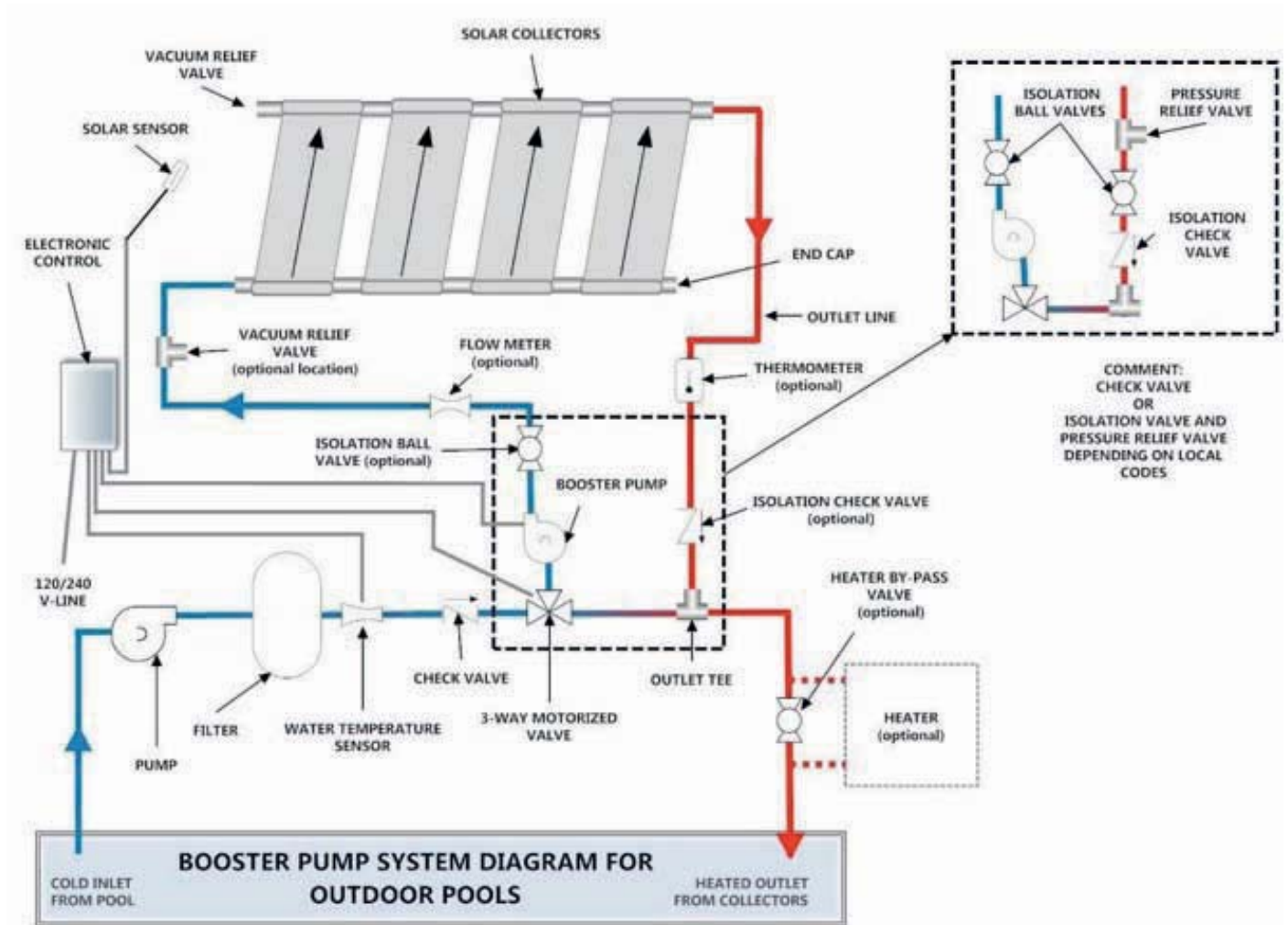

For the latest revision of this manual, or to view the complete unabridged manual, please visit www.aquathermindustries.com/install

An ISO 9001:2008 Registered Manufacturer

Aquatherm Industries, Inc.
1940 Rutgers University Blvd.
Lakewood, New Jersey 08701

Phone: 732-905-9002

Email: info@aquathermindustries.com

